

Item No. 2054

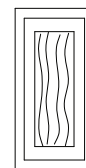

▼ start here

Drawing 1 - Strap Detail

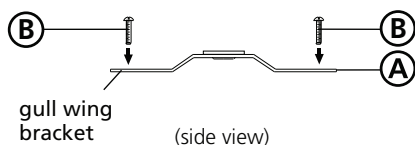

1

1. Find a clear area in which you can work.
2. Unpack fixture and glass from carton.
3. Carefully review instructions prior to assembly.

Drawing 2 - Fixture Mounting

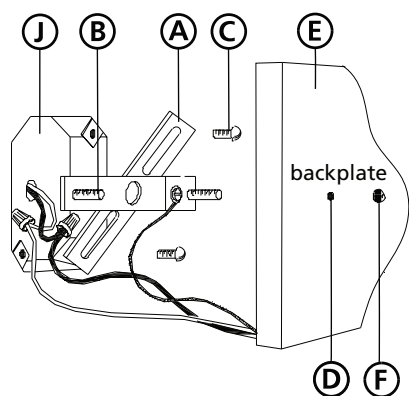

2

1. Prepare mounting strap (A) by threading the two 1 1/4" long mounting screws (B) into the back of the gull wing bracket - see **Drawing 1**.
 - Be sure the holes into which the screws are threaded match the spacing of holes (D) in the back plate (E) - see **Drawings 1 and 2**.
2. Attach mounting strap (A) to junction box (J) using two 1" screws (C) not provided - see **Drawing 2**.
3. Take assembled fixture and locate barrel knobs (5) at bottom of cage assembly (2) - see **Drawing 3**.
4. Unthread barrel knobs (5) and set aside to be used later.
5. Lift bottom of cage assembly (2) until it clears the mounting studs (4).
6. Push up on cage assembly (2) to disengage keyhole slot (3) from anchor knob (6) at top of cage assembly (2). Set cage assembly (2) aside for re-assembly later.

Drawing 3 - Fixture Assembly

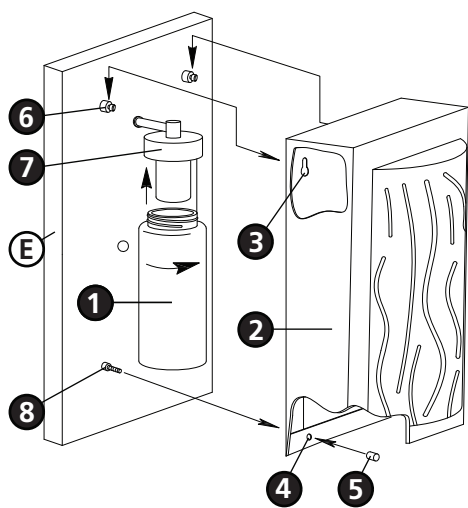

3

Make electrical connections from supply wire to fixture lead wires. Refer to instruction sheet (I.S. 18) and follow all instructions to make all necessary wiring connections. Then refer back to this sheet to continue installation of this fixture.

4

1. To mount fixture to the wall, slide backplate (E) over screws (B) and secure with ball knobs (F) - see **Drawing 2**.

5

1. To install glass, thread cylinder glass (1) into glass holder (7) attached to backplate (E) - see **Drawing 3**.
2. Fixture can now be lamped accordingly.
3. To attach cage assembly (2) to backplate (E), slip keyhole slots (3) over anchor knob (6) located at the top of backplate (E).
4. Slip mounting stud (8) located at bottom of backplate (E) into hole (4) located in the bottom of cage assembly (2).
5. To secure cage assembly (2) to backplate (E), thread barrel knob (5) onto end of mounting stud (8) and tighten.

SAFETY WARNING: READ WIRING AND GROUNDING INSTRUCTIONS (I.S. 18) AND ANY ADDITIONAL DIRECTIONS. TURN POWER SUPPLY OFF DURING INSTALLATION. IF NEW WIRING IS REQUIRED, CONSULT A QUALIFIED ELECTRICIAN OR LOCAL AUTHORITIES FOR CODE REQUIREMENTS.

Drawing 1 - Flush Mount



Drawing 2 - Chain Hung



Drawing 3 - Post-Mount



SAFETY WARNING: READ WIRING AND GROUNDING INSTRUCTIONS (I.S. 18) AND ANY ADDITIONAL DIRECTIONS. TURN POWER SUPPLY OFF DURING INSTALLATION. IF NEW WIRING IS REQUIRED, CONSULT A QUALIFIED ELECTRICIAN OR LOCAL AUTHORITIES FOR CODE REQUIREMENTS.

wiring instructions

Indoor Fixtures

1. Connect positive supply wire **(A)** (typically black or the smooth, unmarked side of the two-conductor cord) to positive fixture lead **(B)** with appropriately sized twist on connector - see **Drawings 1 or 2**.
2. Connect negative supply wire **(C)** (typically white or the ribbed, marked side of the two-conductor cord) to negative fixture lead **(D)**.
3. Please refer to the **grounding instructions** below to complete all electrical connections.

Outdoor Fixtures

1. Connect positive supply wire **(A)** (typically black or the smooth unmarked side of the two-conductor cord) to positive fixture lead **(B)** with appropriately sized twist on connector - see **Drawings 2 or 3**.
2. Connect negative supply wire **(C)** (typically white or the ribbed, marked side of the two-conductor cord) to negative fixture lead **(D)**.
3. Cover open end of connectors with silicone sealant to form a watertight seal.
 - If installing a wall mount fixture, use caulk to seal gaps between the fixture mounting plate (backplate) and the wall. This will help prevent water from entering the outlet box. If the wall surface is lap siding, use caulk and a fixture mounting platform specially.
4. Please refer to the **grounding instructions** below to complete all electrical connections.

grounding instructions

Flush Mount Fixtures

For positive grounding in a 3-wire electrical system, fasten the fixture ground wire **(E)** (typically copper or green plastic coated) to the fixture mounting strap **(1)** with the ground screw **(2)** - see **Drawing 1**.

Note: On straps for screw supported fixtures, first install the two mounting screws in strap. Any remaining tapped hole may be used for the ground screw.

Chain Hung Fixtures

Loop fixture ground wire **(E)** (typically copper or green plastic coated) under the head of the ground screw **(2)** on fixture mounting strap **(1)** and connect to the loose end of the fixture ground wire directly to the ground wire of the building system with appropriately sized twist-on connectors - see **Drawing 2**.

Post-Mount Fixtures

Connect fixture ground wire **(E)** (typically copper or green plastic coated) to power supply ground with appropriately sized twist-on connector inside post. Cover open end of connector with silicone sealant to form a watertight seal - see **Drawing 3**.

▼ start here

1. After securing fixture to the wall it is recommended that the gap between the wall and fixture backplate be sealed with any good quality waterproof caulk or silicone sealant. (NOT INCLUDED) See Drawing 1.

Drawing 1



1. After securing fixture in place it is recommended that the gap between the mounting top and fixture base be sealed with any good quality waterproof caulk or silicone sealant. (NOT INCLUDED). It is also recommended that a small bead of caulk or sealant be put under the ball knobs used to mount fixture. See Drawing 2.

Drawing 2

